

EKU-PORTA

Sliding Door Solutions for All-Glass Openings

EKU-Porta is designed for frameless all-glass architecturally inspired openings, thereby, fulfilling the requirements of a minimalistic design scenario of less hardware and more glass. All EKU-Porta products are engineered and designed to provide for years of optimal operation from a wide variety of top-hung 'clamp-to-glass' type fittings, requiring no glass fabrication. With the extensive range of installation types; wall (fixed or glass), ceiling (surface or recessed), fixed glass, overhead transoms, solutions are easily available for all design criteria. With the available soft-close, EKU-Porta truly achieves functionality for all applications in order to meet/exceed the most discerning clients requirements.



GW/GWF



GU



G



GMD



GFO



EKU-PORTA 100/GWF



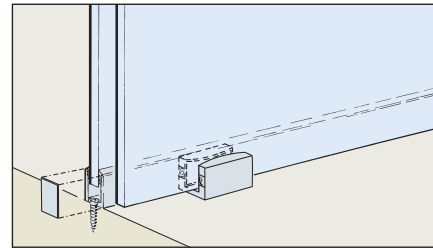
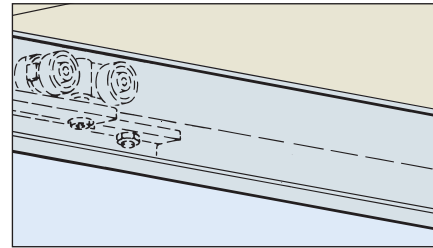







- ✓ 220 lbs. (100 kg) – per panel
- ✓ For one (1) or more sliding and fixed glass panels
- ✓ 5/16" – 1/2" (8 – 12.7 mm) glass thickness
- ✓ NO glass fabrication
- ✓ Maximum door height = 8' - 10 5/16" (2700 mm)
Follow glass fabrication guidelines, if applicable.
- ✓ Suitable for ceiling (surface or recessed)
- ✓ Suitable for simultaneous function (both panels operate with either in operation). See page # 17



Note: Check local glass fabrication guidelines.

- Removable designer soffit for top track and clamp shoe
- Ceiling or wall mounting
- Adjustable track stoppers
- 3-piece floor mounted guide

Technical specifications

 <p>Ceiling mounting</p>	 <p>Tempered safety glass 3/8" - 1/2" (10 - 12.7 mm)</p>	 <p>Single door</p>	 <p>Anodized aluminum (US28)</p>  <p>Stainless steel effect, satin (US32D)</p>
 <p>Wall mounting</p>	 <p>Laminated safety glass 3/8" - 1/2" (10.4 - 12.76 mm)</p>	 <p>Double door (by-parting)</p>	
 <p>Up to 220 lbs (100 kg)</p>	 <p>Soft-close</p>	 <p>Fixed glazing</p>	

EKU-PORTA 100/GWF

Mounting examples

Ceiling mounting

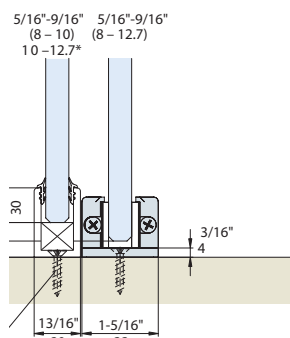
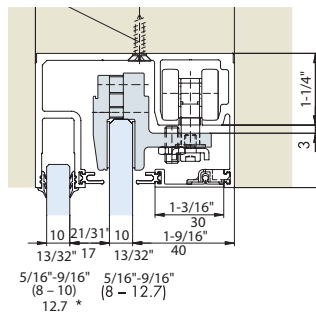

BO 51 210 10, setting block

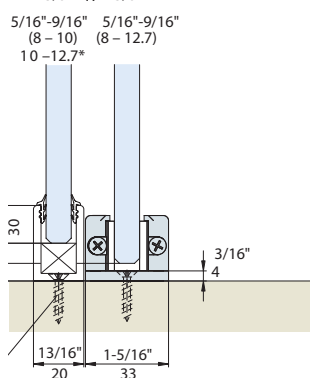
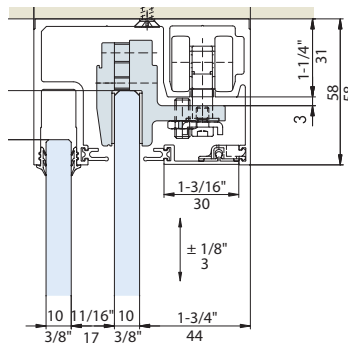

Fixed panel, no slider

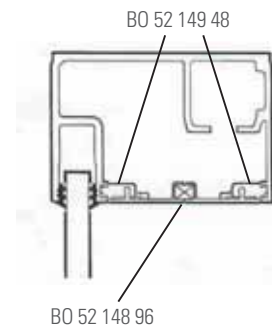

Note: BO 52 148 96 = 8'-0" lengths. Order BO 52 148 60 / 61 / 63 (soffit) * 2
Order BO 52 149 48 (soffit clips).

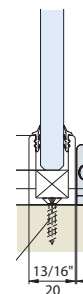

Components to EKU-PORTA 100/GWF

Top track

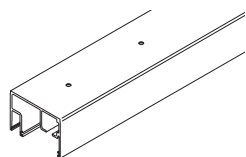

Aluminum · anodized · pre-drilled
· 3 3/8" w x 2 5/16" h (86 x 58 mm)

Art. No.

BO 52 148 50	8'-2 7/16" (2500 mm)
BO 52 148 51	11'-5 13/16" (3500 mm)
BO 52 148 53	19'-8 3/4" (6000 mm)

Fill-in channel to top track

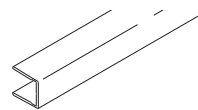

Aluminum · anodized · for top track ·
9/16" x 9/16" (15 x 15 mm) for
BO 52 148 50 / BO 52 148 51 /
BO 52 148 53, to fill in where fixed
glazing does not exist

Art. No.

BO 52 148 52	8'-2 7/16" (2500 mm)
--------------	----------------------

Packaging: 1 pc.

Note: disposable protective cover to top track BO 52 149 49 – 6'-6 3/4" (2000 mm)
Note: track cleaning tool BO 52 148 68

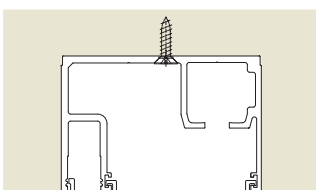

Components to EKV-PORTA 100/GWF

Soffit profile

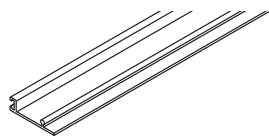

Aluminum · anodized · 1 3/16" x 5/16" (30 x 8 mm) for closing off top track · removable

Art. No.

BO 52 148 60	8'-2 7/16" (2500 mm)
BO 52 148 61	11'-5 13/16" (3500 mm)
BO 52 148 63	19'-8 1/4" (6000 mm)

Packaging: 1 pc.

Note: See BO 52 149 48 for openings wider than 8'-2".

Top track and soffit seal

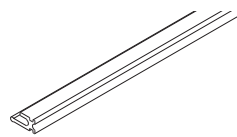

For top track - BO 52 148 45 / BO 52 148 46 / BO 52 149 93 and soffit profile BO 52 148 60 / BO 52 148 61 / BO 52 148 63 · rubber · black, 65'-7 3/8" (20 m)

Art. No.

BO 52 148 62	65'-7 3/8" (20000 mm)
--------------	-----------------------

Note: length required = DLOW * 2

Components for fixed glazing

U-channel for fixed glazing, bottom

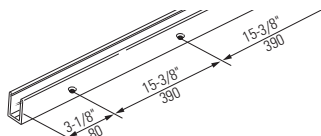

Aluminum · anodized · pre-drilled

Art. No.

BO 52 148 55	8'-2 7/16" (2500 mm)
BO 52 148 56	11'-5 13/16" (3500 mm)
BO 52 149 85	19'-8 1/4" (6000 mm)

Packaging: 1 pc.

Note: gasket BO 52 148 58 for 3/8" fixed glass panels



Note: setting blocks BO 51 210 10

Cover cap set and fasteners for U-channel

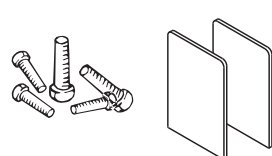

Cover caps – aluminum, anodized
Fasteners – steel · zinc-plated

Art. No.

BO 52 148 57

Packaging: 1 set (2 cover caps for BO 52 14855 / BO 52 148 56 / BO 52 149 85)

Gasket for fixed glazing

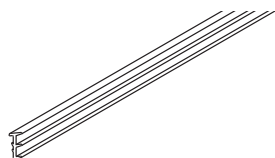

Rubber · black

Art. No.

BO 52 148 58	65'-7 3/8" (20000 mm)
--------------	-----------------------

Packaging: 1 roll

Note: for 3/8" (10 mm) glass only

Note: for 1/2" (12.7 mm) glass, use RTV silicone, black

Industrial construction silicone RTV 4500



100% acetoxy silicone sealant - permanent flexibility - excellent weatherability with long life, tensile strength 363 psi - 10.3 fl oz (305 ml) cartridges

Art. No.

BA 45 000 03S

Packaging: 1 tube

Components to EKV-PORTA 100/GWF

Clips to soffit profile

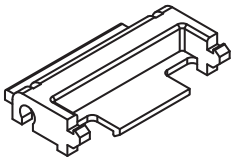

Soffit clips · plastic · grey · placed every 7 7/8" (200 mm) on center

Art. No.

BO 52 149 48

Packaging: 12 pcs.

Note: BO 52 148 35, fitting set, includes (12) pcs, enough for up to a 8'-2 1/2" wide opening. Order (1) additional set of BO 52 149 48 for each additional opening width of 8'-2 1/2".

Track cleaning brush

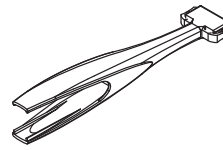

Track cleaning brush · plastic · grey with brush

Packaging: 1 pc.

Art. No.

BO 52 148 68

EKV-Porta 100/GWF fitting set

Art. No.

BO 52 148 35

Packaging: 1 set = 1 sliding door

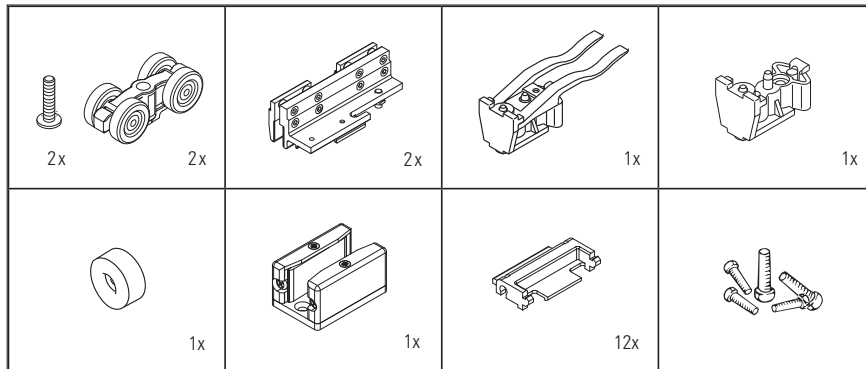

Special machining to top track (service port)

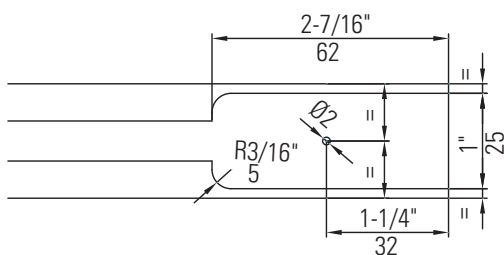

Note: Bohle can provide this notch prior to shipping.

Cover cap to service port

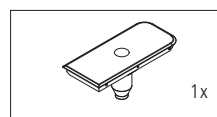

Packaging: 1 pc.

Art. No.

BO 52 148 69 plastic, light grey including fastener

Milling jig for service port

Packaging: 1 pc.

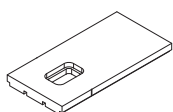

Art. No.

BO 52 148 66

Carbide router bit

Packaging: 1 pc.

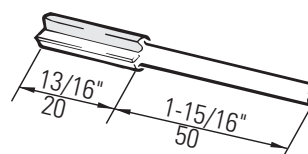

Art. No.

BO 52 148 67

EKU-PORTA 100 Soft-close

Top track

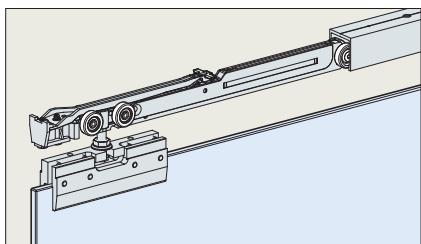

Art. No.

BO 52 148 70

Packaging: 1 pc.

"i" – for EKU Porta 100

Suitable for:

- ✓ Porta 100/G
- ✓ Porta 100/GF
- ✓ Porta 100/GFO
- ✓ Porta 100/GM
- ✓ Porta 100/GMD

Set:

- ✓ Single soft-close for one (1) door order one (1)
BO 52 148 70
- ✓ Dual soft-close for one (1) door order two (2)
BO 52 148 70

Note: door width is important!

Single operation: minimum door width = 17 3/16" (436 mm)

Dual operation: minimum door width = 33 1/16" (840 mm)

EKU-PORTA 100 Spare components

Locking nut



Locking nut · M8 · steel · galvanized

Art. No.

BO 52 149 95

Packaging: 1 pc.

Note: G / GF / GFO / GM

Suspension bolt

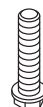

Suspension bolt · M8 x 35 mm · steel
· galvanized

Art. No.

BO 52 149 76

Packaging: 1 pc.

Note: G / GF / GFO / GM

Suspension bolt

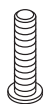

Suspension bolt · M8 x 30 mm ·
steel · galvanized

Art. No.

BO 52 149 63

Packaging: 1 pc.

Note: GW / GWF